

VDW 1407

Options Optionen

- > Hydraulic or electric shifting
Hydraulische oder elektrische
Schaltung
- > Mounting plates
Montageplatten
- > Speed measuring
Drehzahlmessung
- > Pendulum part
Kardangelenk
- > Path measurement for relative
adjustment
Wegmessung für
Relativverschiebung



X-SERIES



VIBRATION HEADS



CORING HEADS



DOUBLE HEAD
DRILLING SYSTEMS



ROTARY HEADS
FOR PILE RIGS



DRILLING
ACCESSORIES

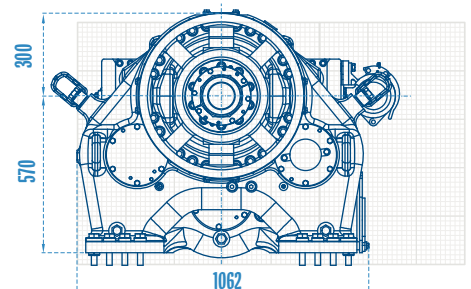
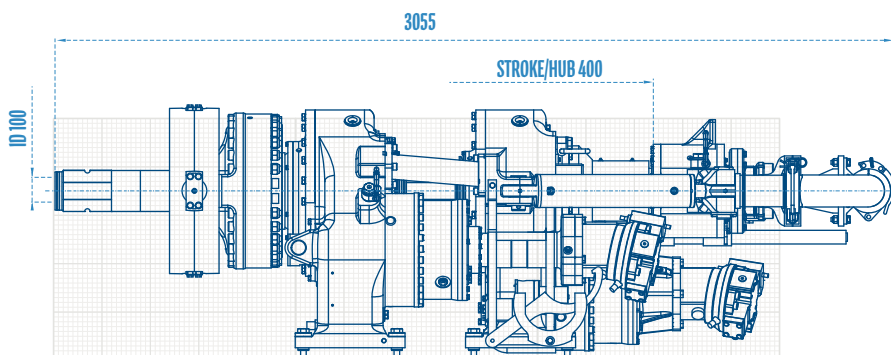

Technical Specifications are subject to modifications without prior notice and incurring responsibility for machines previously sold. The shown machines may have optional equipment. Technical data do not consider power losses. Error misprints reserved. / Technische Änderungen ohne Vorankündigung und Verpflichtung gegenüber früher gelieferten Geräten. Die abgebildeten Geräte können Sonderausstattungen haben. Technische Daten ohne Berücksichtigung des Wirkungsgrades. Irrtum und Druckfehler vorbehalten.



3950 kg **Weight** Gewicht
500 kN **Traction** Zugkraft

Gear box 1 / Casing VDW 1407
Getriebe 1 / Rohr

Gear box 2 / Auger VDW 1407
Getriebe 2 / Schnecke

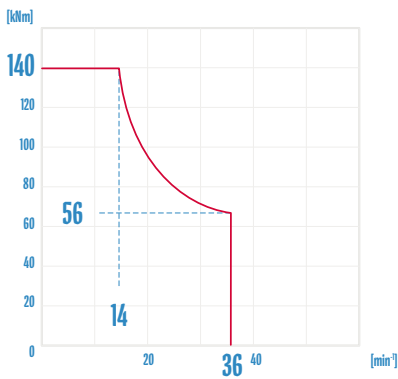

p = 320 bar & Q = 400 l/min

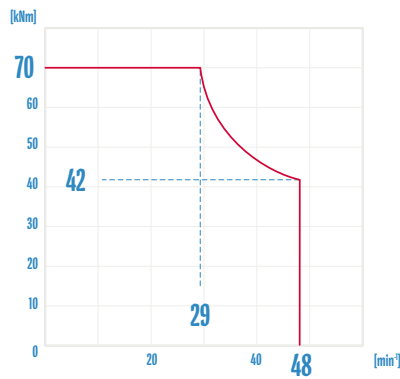

p = 320 bar & Q = 400 l/min